

DEGEN[®]

DE1103

PLL FM STEREO/SW.MW.LW DUAL CONVERSION SYNTHESIZED WORLD RECEIVER

DEGEN[®]

PLL FM STEREO/SW.MW.LW DUAL CONVERSION SYNTHESIZED WORLD RECEIVER

DE1103

OPERATION MANUAL

POWER SUPPLY	1
POWER INDICATION	3
BATTERY CHARGER	4
BEFORE OPERATION.....	6
SET THE CLOCK	7
TURN ON, OFF THE UNIT	8
VOLUME CONTROL & LOCAL / DX SWITCH.....	9
BAND, METER BAND CONVERSION.....	10
SET SLEEP TIME	11
SET ALARM ON, OFF	12
TUNING INTO A STATION.....	14
PRESET STATIONS	18
DELETE STATIONS.....	19
HOLD & BACKLIGHT	20
TONE SELECTION & NARROW/WIDE BAND	21
RESET & LINE OUT	22
EARPHONES & FOLDING STAND	23
RECEIVING SSB / CW	24
USING ANTENNA	25
SPECIFICATIONS.....	27

● OPERATING ON BATTERY

2 METHODS

▶ BATTERY INSTALLATION

1. Slide the battery lid.
2. Insert four AA batteries with correct polarity as shown in the compartment.
3. Close the lid of compartment.

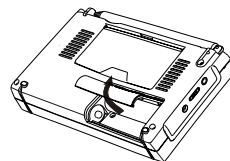

- ◆ Disconnect the AC adaptor plug with the unit while using batteries to supply power.
- ◆ Do not try to recharge no-rechargeable batteries.
- ◆ Do not mix old batteries with new ones.
- ◆ When the unit is not being used for a long period of time, remove batteries to avoid damage from battery leakage and corrosion.
- ◆ If battery leakage occurs, wipe the battery compartment with a soft cloth before inserting new batteries.

▶ BATTERY REPLACEMENT

1. When the sound becomes weak and distorted, battery power indicates , replace batteries or charge the batteries immediately, otherwise the unit will shut off automatically.
2. All memories are permanently stored. However, when the power supply is broken off, the clock reverts to the default setting 0:00, it needs to be reset.
3. The clock time will not lose if you replace new batteries in 3 minutes.

POWER SUPPLY

● OPERATING ON AC

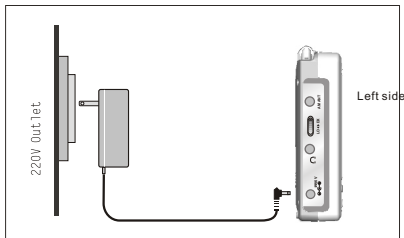

1. Plug the adaptor into a 220V AC power outlet.
 2. Insert the adaptor' s small connector plug into the DC JACK ② .
- ◆ If use AC adaptor to supply power, adaptor surface may a little heat.
 - ◆ If the AC adaptor is connected, the unit automatically switches to the AC adaptor power, and installed batteries are no longer in use.
 - ◆ Disconnect the AC adaptor with the outlet,if the AC adaptor is not being used.
 - ◆ The backlight will keep on illuminated when using AC adaptor.
 - ◆ Remove the batteries if you want to use AC adaptor for a long period of time.
 - ◆ Only Supplied AC adaptor should be used for this unit.





POWER INDICATION

Power indicator is a trapeze pattern, it is hidden when receiving programme. User can check power level by press **▶VOL▶** .



- ◆ If the power is exhausted, the unit will turn off automatically.
- ◆ When using rechargeable batteries, if  appears, batteries need to be recharged.

BATTERY CHARGE

1. Install four AA rechargeable batteries with correct polarity.
2. Plug the adaptor into an 220V AC power outlet, connect the other side securely to DC Jack .
3. In power off mode, hold down button , in the meantime turn jog dial wheel "TUNE" to set charging time from 1~23 hours, then release button , charging starts. Or press number button to input charging hours directly, then quickly press button  to confirm.
4. Indicator  flashes during battery charging.
5. When preset charging time reaches, the unit stops charging automatically.

► Notes:

1. Charging time should be set in power off mode, but you can turn on the unit and listen programme during charging process.
2. There is no effect on battery charge if the unit is alarm on during charging.
3. Charging time can be calculated as: Charging hours = Battery Power (mAH) / 100mA (charging current).
4. In power off mode, hold down  to check rest charging hours.
5. Battery charge will be terminated once the setting charging hours reaches.
6. Do not charge the batteries with fully power.

BATTERY CHARGE

CAUTIONS:

- ◆ If  constantly displays, the unit is in charging process.
- ◆ Please select high-quality rechargeable batteries.
- ◆ When using new rechargeable batteries or those which have not been used for a long time, charge them fully, then use them until they have completely run down. Repeat this cycle two more times, then those batteries can be used normally.
- ◆ Do not leave fully charged batteries unused for a long time.
- ◆ Do not mix old batteries with new ones.



Do not try to charge dry batteries, avoid batteries leakage or explosion!

► Check Batteries/AC Adaptor

Check if batteries are inserted with correct polarity. Check if AC adaptor is connected in correct way. Please use supplied AC adaptor only.

► Check Hold Button

If  appears in the display, the unit is locked. All buttons except HOLD button become inoperative. Unlock it to resume operation (Details refer page 20).

► Check Local/DX Button



Normally, set Local /DX button to DX position  .

► Display Time

1. When the unit is off, current time indicates in the display.
2. When the unit is on, press  to display current time 5 seconds.

► Set The Clock

The default time of this unit is 0:00. Time has to be set in power off mode.

1. Hold down button  for 2 seconds to set hour, hour number flashes for 30 seconds.
2. While hour number is flashing, turn the jog dial “TUNE” to set current hour.
3. After hour setting, press  to set minute, minute number flashes.
4. Turn jog dial wheel to adjust minutes.
5. After setting, press  to confirm.

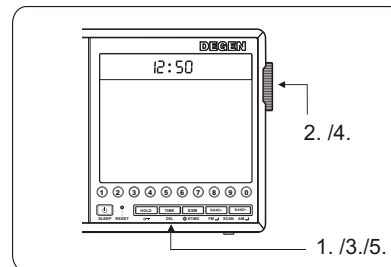

- ◆ Please go to next step within 30 seconds, or the time setting will be invalid.

TURN ON、 OFF THE UNIT

▶ Power On / Off the unit

Press **SLEEP** to turn on the unit manually, press **SLEEP** again to turn it off. Each time turn on the unit, it will receive the last station you ever heard.

▶ Alarm On / Off

Two groups of alarm on /off time can be set in 24 hours. Station, volume can be set as well. The unit will turn on at preset time and will turn off after preset off time reaches. After setting, indicator “ALARM 1” “ALARM 2” constantly appears (Details refer to Page 12).

▶ Sleep Timer

Sleep time can be select from 1-99 minutes. After setting, indicator “SLEEP” constantly appears, when preset sleep time reaches, the unit will turn off automatically.(Details refer to Page 11).

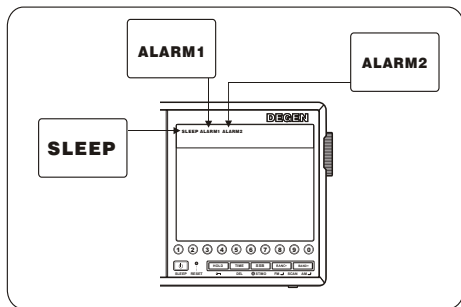

VOLUME CONTROL & LOCAL/DX SWITCH

● Volume Control

The volume is divided to 64 levels (0~63), default level after reset the unit is level 40. When adjusting volume, corresponding level number appears in the display.

Method 1: Turn on the unit, press **VOL**, “VOL” flashes for 3 seconds, turn jog dial wheel to adjust volume.

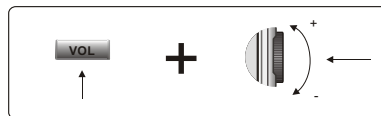

Method 2: Press number button to input volume level directly, then press **VOL** to confirm.

For example: set volume to level 30:



◆ Please go to next step within 3 seconds.

● Local /Dx Switch



In SW or MW band, set LOCAL/DX switch to a proper position will increase reception.

Generally, set the switch to DX position, unless there is a strong interference or when you are listening to local stations.

NOTE: If LOCAL/DX switch is set to LOCAL position, some strong signal stations may receive clearly, but most weak signal stations can not be received.

● Band Conversion

After turn on the unit, press **BAND-** or **BAND+** repeatedly to select your desired band, band indicator shows corresponding band in the display.

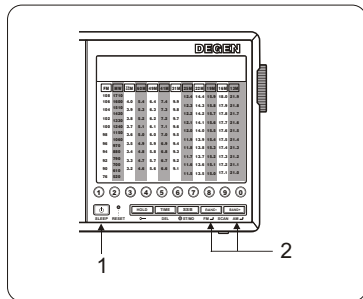

User can set sleep time from 1~99 minutes with the unit on or off either.

Method 1:

1. Press number button to input sleep time, the input number appears for 3 seconds.
2. Press **SLEEP** to confirm within 3 seconds.
3. Indicator “SLEEP” constantly appears in the display, sleep function works, when the setting sleep time reaches, the unit will shut off automatically.

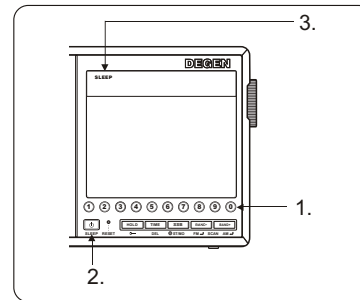

Method 2: 1. Hold down **SLEEP**, turn jog dial as well to select sleep time.

2. Indicator “SLEEP” constantly appears in the display.

- ◆ Indicator **SLEEP** will constantly display after sleep time is set.
- ◆ You have to go to next step within 3 seconds, otherwise, the unit will exit from sleep time setting.

In power off mode, two groups of alarm on/off time can be set in 24 hours. Station、volume can be set as well.

▶ Set Alarm 1

1. In power off mode, hold down button **M/F** for 3 seconds, hour number flashes.
2. Turn jog dial “TUNE” to set hour, then press **M/F** to set minutes.
3. Turn “TUNE” to set minutes, then press **M/F** to go into station number setting.
4. Turn “TUNE” to select stored station number, then press **M/F** to go into volume setting.
5. Turn “TUNE” to adjust volume, then press **M/F** to set auto off time(from 5~99 minutes).
6. Turn “TUNE” to set auto off time.
7. Press **M/F** to confirm setting. “ALARM 1” constantly appears, when preset on / off time reaches, the unit will on / off automatically.

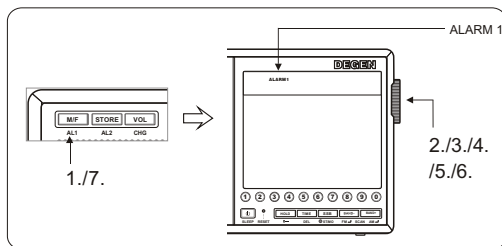

Note:

- ◆ Press **M/F** or **STORE** to skip one step or confirm last setting.

▶ Set Alarm 2

1. In power off mode, hold down button **STORE** for 3 seconds, hour number flashes.
 - ◆ Other operations are same as Alarm 1 setting.
 2. Finally, press **STORE** to confirm, “ALARM2” constantly appears, when preset on / off time reaches, the unit will on / off automatically.
- ◆ If alarm 2 time is followed alarm 1, the setting of station and volume will supersede alarm 1.
 - ◆ Alarm on/ off is valid when you are listening radio programme. If you do not change the alarm setting, it is still valid on next day.

▶ Cancel Alarm On、Off

● Cancel Alarm 1

In power off mode, press button **M/F**, the unit defaults last Alarm 1 setting. Press **M/F** again to cancel, indicator “ALARM 1” disappears from the display.

● Cancel Alarm 2

In power off mode, press button **STORE**, the unit defaults last Alarm 2 setting. Press **STORE** again to cancel, indicator “ALARM 2” disappears from the display.

You can use below 4 methods to find a desired station, when tuning into a AM station,  appears to indicate signal strength. The more steps appear, the stronger signal it is.

● JOG DIAL TUNING

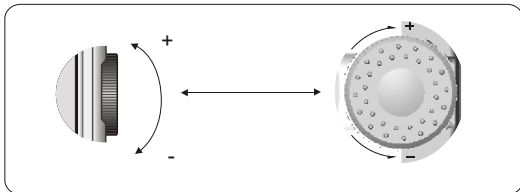

1. Turn on the unit, select desired band.
2. Press  and turn the centre of the jog dial "TUNE" with one finger to quickly go to a desired station, watch the change of the frequency.
3. When near a station, you can use two fingers to turn the jog dial wheel slowly to find the exact frequency.







- ◆ When use jog dial tuning, the frequency step for FM is 25K; for AM is 1K.
- ◆ The highest turning speed is 80 step/circle.

● DIRECT FREQUENCY ENTRY

Direct frequency entry makes it extremely easy to tune into a station that you know its exact frequency. Frequency can be input without selecting band first.

1. Turn on the unit, press button 0~9 to enter frequency.
2. Press corresponding button to confirm: Press  to confirm a FM band station, press  to confirm a AM band station.

Sample 1: FM 89.80MHz

 ⇒  ⇒  ⇒ 

(FM band: decimal point and last digitals of "0" can be ignored.)





Sample 2: AM 810KHz

 ⇒  ⇒  ⇒ 

Sample 3: AM 120KHz

 ⇒  ⇒  ⇒ 

Sample 4: AM 1000KHz

 ⇒  ⇒  ⇒  ⇒  ⇒ 

- ◆ Next number has to be entered within 3 seconds after the fore number is entered.
- ◆ If an invalid frequency is entered, "Err" will appear in the display.
- ◆ The frequency step for direct entry is 1KHz for AM, and 100KHz for FM.

● AUTO SCAN TUNING

1. Turn on the unit, change to your desired band.
2. Hold down **BAND-** or **BAND+** for more than 2 seconds, release when the frequency changes, the unit starts tuning into stations from current frequency. When a station is tuned in, scanning pauses for 3 seconds and the tuned station is heard. The scanning will continue if no further operation.
3. If a station is tuned in, you can use jog dial to fine tune.
4. Press any button to stop auto scan tuning.

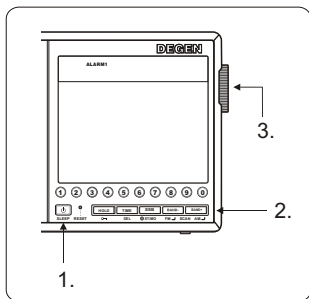

- ◆ In auto scan tuning, the frequency step is 100K for FM; 1K for MW and 5K for SW.
- ◆ The unit will scan within the frequency range of chosen band or meter band.

● MEMORY SCAN TUNING

1. Turn on the unit, press **M/F** to go into memory scan tuning mode, “MEM” appears in the display.
2. Turn the jog dial to tune into preset stations.
3. If you remember the preset number clearly, you can enter number button directly, and press **M/F** within 3 seconds to tune into the station.

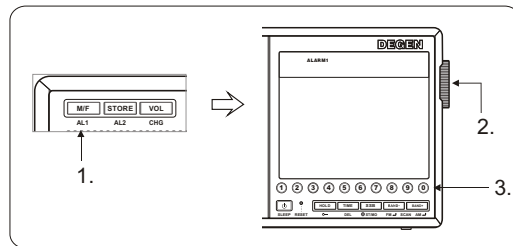

- ◆ Empty station number will be skipped automatically.
- ◆ If an empty station number is entered, indicator “Err” will appear in the display.

PRESET STATIONS

There are total 255 stations can be preset in two area: convenience area or hidden area. All memories are permanently stored.

1. Turn on the unit, tune into a desired station by jog dial tuning, scan tuning or direct entry.
2. Hold down **STORE**, indicator “MEM” flashes.
3. Turn jog dial wheel to find a desired number.
4. Press **STORE** to store current frequency.

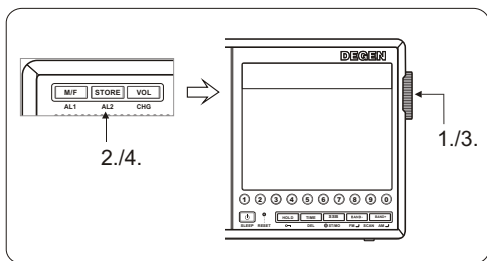

- ◆ Up to 100 stations can be preset in convenience area, from 0~99.
- ◆ Total 156 stations can be preset in hidden area, from 0A~0F …… F0~FE.
- ◆ For short wave (SW) broadcasts, the frequency may different even for the same station at different time and period. Presetting different frequencies for the same station in the same area will let you tune into that station easily.
- ◆ If a preset number is already occupied, the new frequency with same preset number replaces the old one.

DELETE STATIONS

▶ DELETE A SINGLE STATION

1. Turn on the unit, hold down **STORE**.
2. At the same time, turn jog dial wheel, “MEM” flashes and frequency changes, find the station you want to delete.
3. Continue hold down **STORE**, and press button **TIME**, current station is empty, indicator “MEM” changes to “VOL”.

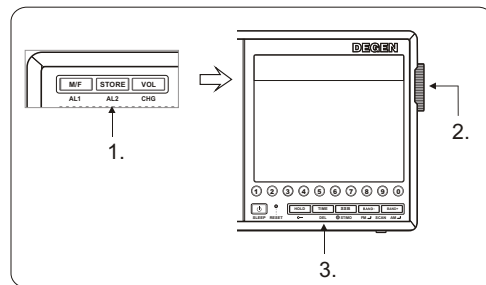



▶ DELETE ALL PRESET STATIONS

Hold down **SLEEP**, **HOLD** and **TIME** at the same time, then press **RESET**, all preset stations will be delete.

● HOLD FUNCTION

The hold function can be used to avoid any accidental operation when the unit is being carried or used.

1. Press **HOLD** button, indicator  appears, hold function is activated, all buttons except HOLD button become inoperative. (If the unit is on, press  can turn off the unit.)
2. Hold down **HOLD** button for 1 second to cancel hold function,  disappears from the display.

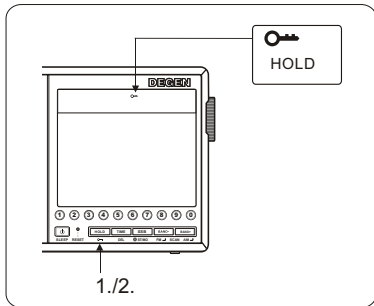

● BACK LIGHT FUNCTION

There are 3 kinds of back light mode to select: normal, always-on and back light off.

1. Normal: press any button will start up the orange back light of the display and buttons. The backlight will be off automatically if no further operation in 15 seconds.
2. Always-on: If the power is supplied by AC adaptor, the back light will always on.

3. Back light off: Push the back light switch to OFF position, the backlight will off, push the switch to ON to resume back light function.

● TONE SELECTION

▶ STEREO/MONO

Stereo is suitable for strong signal music broadcast, mono is suitable for weak signal and voice program.

Press **STEREO/MONO** button to convert between stereo and mono, the LCD will on when choosing stereo.

▶ NEWS/MUSIC

Push the switch  to corresponding position when listen news or music.

● NAR./WIDE

When listening AM band program, push NAR./WIDE switch to proper position will increase reception result. For this unit, the 1st IF is 55.845MHz, 2nd IF is 450KHz.

In AM band, push the NAR./WIDE switch  up to select "WIDE", push the switch down to select "Narrow"

Wide band has a better tone reception than narrow band, but it is noisier than narrow band reception.

RESET & LINE OUT

● RESET

If the unit operates erratically, press RESET to resume normal operation. Reset function will not erase all of the memories except the clock time.

● LINE OUT

You can output the radio broadcasting by connecting the unit to external appliance with a connecting cable inserted into LINE OUT jack.

Volume adjustment and news/ music selection will not effect output.

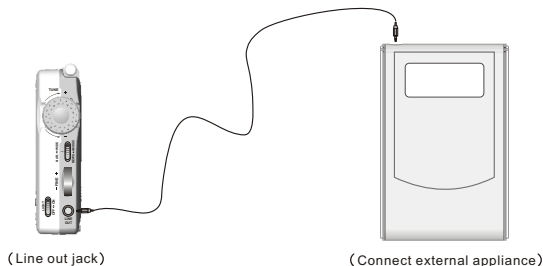

EARPHONES & FOLDING STAND

● LISTENING WITH EARPHONES

When listening to stereo reception, normally use earphones, and the speaker will stop work automatically.

Speaker has MONO effect only.

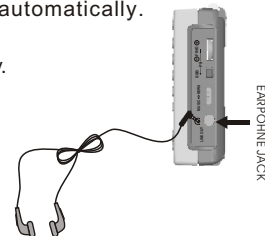

Notes On Earphones

- Avoid using earphones at high volume, if you experience a ringing in your ears, reduce volume or stop using it.
- Set sleep time when listening radio before sleeping.
- Do not use earphones while driving or cycling, it can also be potentially dangerous to play your earphones at high volume while walking, especially at pedestrian crossing.

● USING FOLDING STAND

Pull out the folding stand in rear panel, extending the telescopic antenna straight upward.



RECEIVING SSB/CW

1. Turn on the unit, SSB signal can be received at the frequency range of 100~29999KHz.
2. Tune into a AM station with medium strong signal.
3. Press SSB button, turn jog dial to tune into a SSB frequency.
4. When find a SSB signal, tune the SSB FINE Knob to have the best reception.

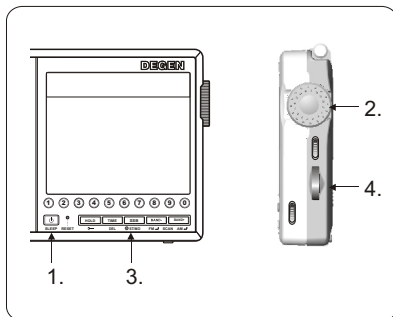

USING ANTENNA

FM Reception

Telescopic antenna functions as FM antenna, keep it extended and change its length and direction to find the position which gives the best reception.

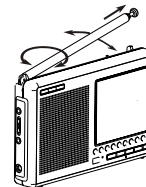

(FM)

MW Reception

Ferrite antenna inside the unit functions as MW antenna, it is strongly effected by the reception direction. Therefore, when listening to MW broadcast, rotate the unit to find the position which gives the best reception.

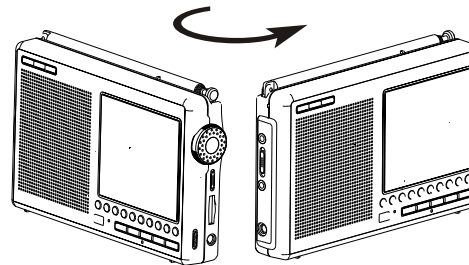

(MW)

USING ANTENNA

SW Reception

Telescopic antenna functions as SW antenna. Extending the antenna straight upward to get the best reception.

- ◆ Normally, set the LOCAL/DX switch 23 to DX position when listening SW programme.

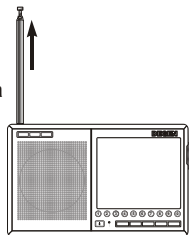

(SW)

External Antenna

If FM or SW reception is too weak, use supplied extra- long external antenna to improve reception.

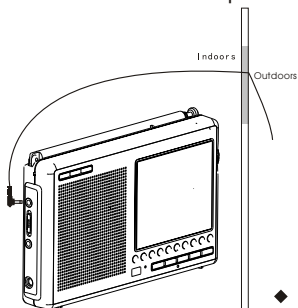

Keep the external antenna straight, insert one side to the ext. Jack 22 of the unit, another side outdoors.

- ◆ If the signal is too strong when using external antenna, set the Local/DX switch to Local position.

△ Do not use external antenna during a thunder storm day.

SPECIFICATIONS

1. Frequency Range			
FM	76.00 - 108.00 MHz		
AM	100 - 29999 KHz		
SW 1710~29999KHz			
90m	3.160 - 3.455 MHz	25m	11.510 - 12.155 MHz
75m	3.860 - 4.055 MHz	22m	13.510 - 13.905 MHz
60m	4.710 - 5.105 MHz	19m	15.010 - 15.705 MHz
49m	5.910 - 6.255 MHz	16m	17.260 - 18.105 MHz
41m	7.010 - 7.405 MHz	13m	21.410 - 21.955 MHz
31m	9.170 - 9.995 MHz	11m	25.610 - 26.100 MHz
2. Noise LimitSensitivity			
FM	≤ 10 μV		
MW	≤ 1mV/m		
SW	≤ 20 μV		
3. SW Selection: Wide band ≥ 40dB Narrow band ≥ 50dB			
4. AM2nd IF Wide band < 6KHz Narrowband < 4KHz			
5. Power Supply: Battery: 4 AA batteries External power: DC in 8v 300mA Recharging time: 1~23 hours			
6. Speaker: D77mm			
7. External Earphones: D3.5mm			
8. Dimensions: Approx. 165*105*29mm			
9. Weight: Approx. 300g (excl.batteries)			